



Assembly and Installation Instructions for Model's

20176WV

CAUTION - RISK OF FIRE

Installation of this fixture should be done by a licensed electrician or by a person familiar with local electrical codes and the construction and operation of this fixture.

Warning please make sure the electrical breaker is shut off before commencing with this installation

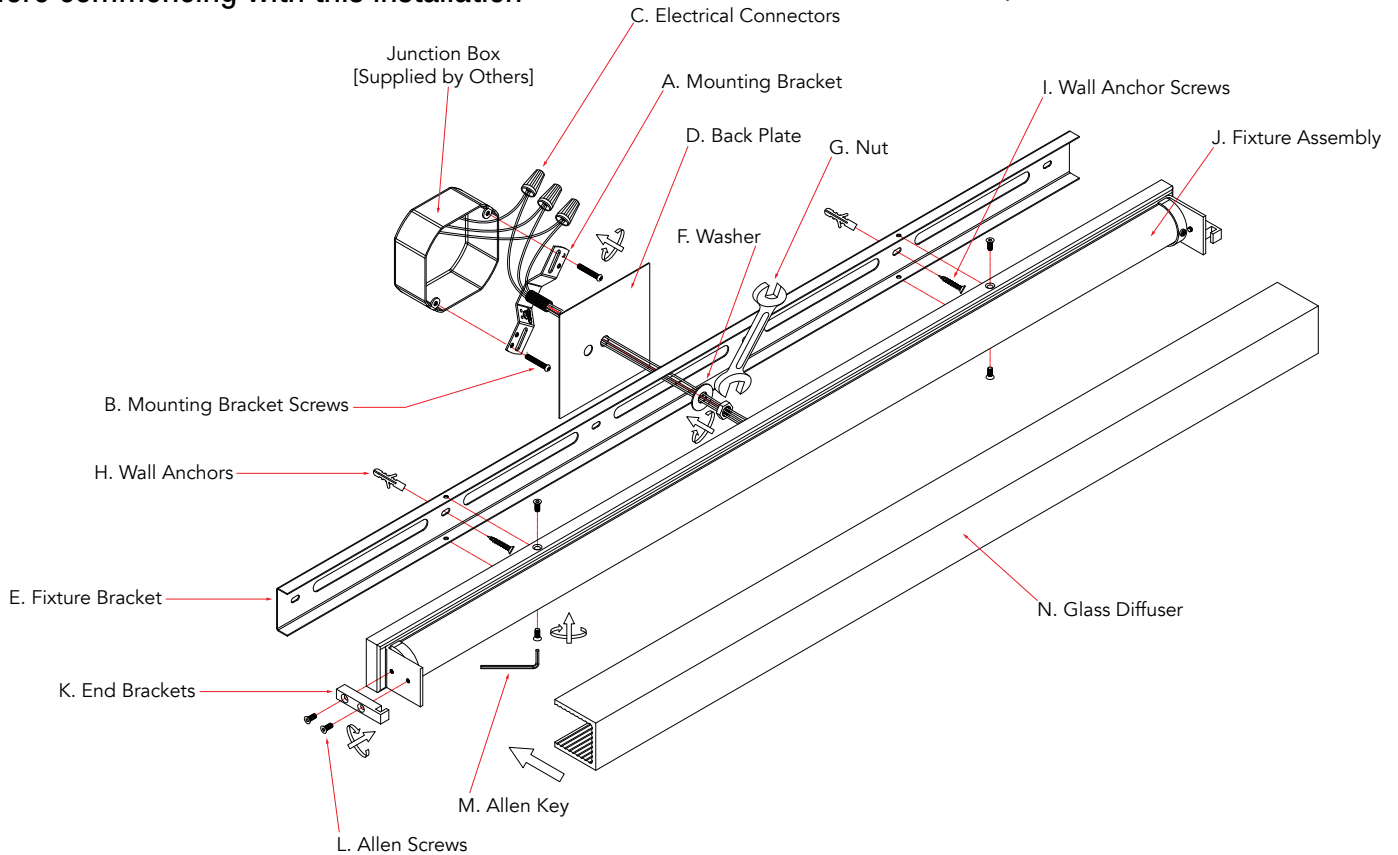

Package Contents

Part	Description	Quantity
A	Mounting bracket	1
B	Mounting bracket screws	2
C	Electrical connectors	3
D	Back plate	1
E	Fixture bracket	1
F	Washer	1
G	Nut	1
H	Wall anchors	2
I	Wall anchor screws	2
J	Fixture assembly	1
K	End brackets	2
L	Allen screws	8
M	Allen key	1
N	Glass diffuser	1

Installing the fixture

please ensure the electrical breaker is in the Off position before commencing

- 1 Connect the supply wires to the fixture wires using the supplied electrical wire connectors (**C**). White supply wire to the White fixture wire, Black supply wire to Black fixture wire and the ground Bare Copper or Green wire to the Green fixture wire. Once the electrical wire connectors are securely fastened it is recommended to tape these connectors with electrical tape.
- 2 Attach the Mounting bracket (**A**) to the Junction Box [Supplied by Others] using the Mounting bracket screws (**B**).
- 3 Place the Back plate (**D**) over the Mounting bracket (**A**) and line up the Fixture bracket (**E**) to mark where the Wall anchors (**H**) will be placed.
- 4 Insert the Wall anchors (**H**) into their marked positions.
- 5 Secure the Fixture bracket (**E**) to the Back plate (**D**) and Mounting bracket (**A**) using the Washer (**F**) and Nut (**G**) provided.
- 6 Secure the Fixture bracket (**E**) to the wall by inserting the Wall anchor screws (**I**) into the Wall anchors (**H**).
- 7 Attach the Fixture Assembly (**J**) to the Fixture bracket (**E**) using four of the Allen screws (**L**) and Allen key (**M**) provided.
- 8 Secure the Glass diffuser (**N**) to the Fixture assembly (**J**) using the End brackets (**K**) and remaining Allen screws (**L**).
- 9 Switch on the electrical breaker switch and your new fixture is ready for many years of trouble free use.