



Assembly and Installation Instructions for Model's

500220DW



CAUTION - RISK OF FIRE

Installation of this fixture should be done by a licensed electrician or by a person familiar with local electrical codes and the construction and operation of this fixture.

Warning please make sure the electrical breaker is shut off before commencing with this installation

Read and familiarize yourself with these instructions before commencing

This fixture is certified for ceiling mounting is suitable for Wet locations

Package Contents		
Part	Description	Qty
A	Mounting bracket	1
B	J-Box screws	2
C	Fixture assembly	1
D	Wire connectors	3
E	Fixture mounting screws	2
F	Shroud	1
G	Shroud attachment screws	2

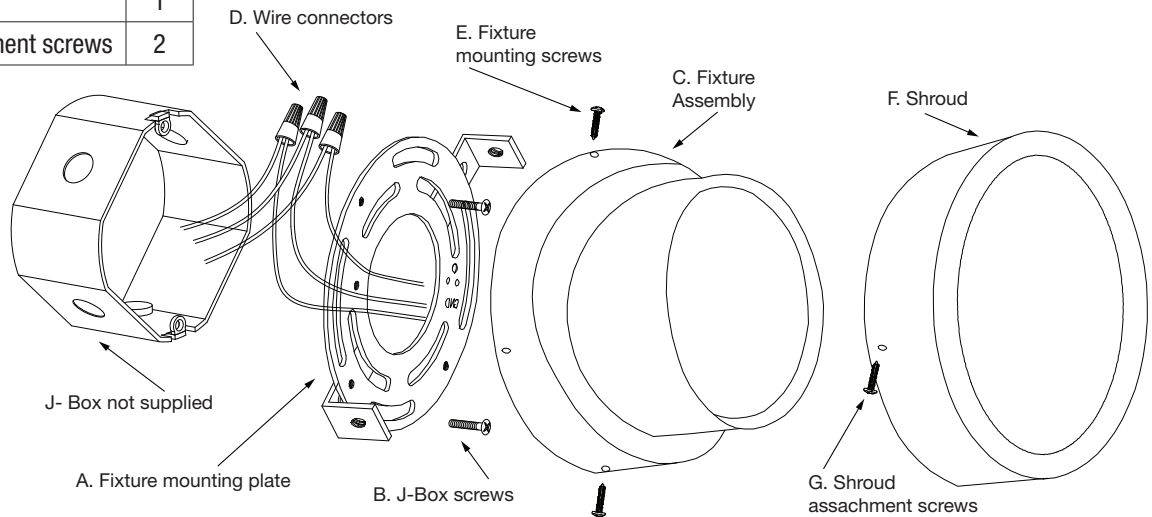
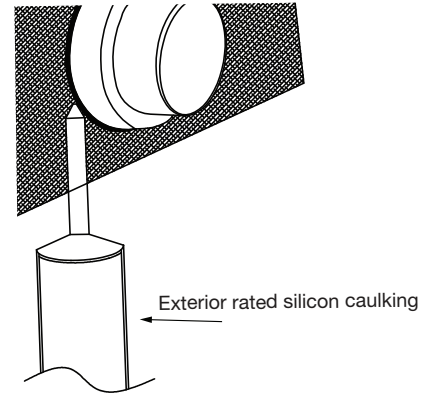

Installing the fixture *please ensure the electrical breaker is switched off before commencing*

- 1 Attach the supplied Mounting bracket (A) with the two supplied Mounting plate bracket (B) to the Junction box.
- 2 Connect the supply wires to the fixture wires using the supplied electrical wire connectors (D). White supply wire to the White fixture wire, Black supply wire to Black fixture wire and the ground Bare Copper or Green wire to the Green fixture wire. Once the electrical wire connectors are securely fastened it is recommended to tape these connectors with electrical tape.
- 3 Attach the Fixture assembly (C) to the mounting bracket (A) with supplied Fixture mounting screws (E)
- 4 Attach the Shroud (F) to the fixture assembly and secure in place with supplied Shroud attachment screws (G)
- 5 **Caulk** the fixture to prevent water entering the electrical box.
- 6 Switch on the electrical breaker switch and your new fixture is ready for many years of trouble free use

Instructions for Outdoor Fixtures and Maintenance Guidelines

Thank you for choosing an Abra outdoor fixture for your lighting needs. Proper installation and maintenance are essential to ensure the longevity and optimal performance of your fixture. Below are some guidelines to help you get the most out of your luminaire:

Regular Cleaning:

Periodical cleaning is crucial to remove salt, dirt, and other debris that can accumulate on the surface of your light that can cause premature failure of the finish and to avoid the finish becoming marred it is recommended to do the following at regular intervals

- Hose down the fixture with clean water
- If there is a residue build up, gently wash the fixture with dishwash solution.
- Avoid using harsh chemicals that may damage the materials or finish of the fixture.
- Rinse thoroughly with clean water to remove any residue.

Inspection and Maintenance:

Periodically inspect your light to ensure they are in optimal condition. Here's what to look for during inspections:

- Check for signs of corrosion, especially in coastal areas where salt exposure is higher.
- Inspect for loose connections and tighten them if necessary.
- Ensure all seals are intact and re-calk if damaged.

By following these guidelines, you can prolong the durability of your lighting fixtures and ensure they continue to provide reliable and efficient outdoor lighting for years to come. If you have any further questions or concerns, please don't hesitate to contact us for assistance.