

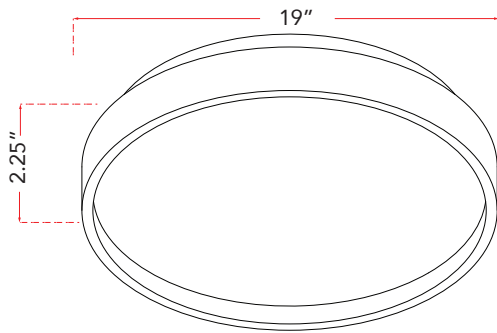

ABRA MODEL **30054FM-BL** Slim Acrylic Flushmount
 FAMILY NAME **Tambourine**



| FIXTURE MATERIAL | | | |
|------------------|----------------------|---------------|-----------------|
| Frame Material | Finishes Available | Diffuser Type | Diffuser Finish |
| Acrylic | BL-Black WH-White | Acrylic | Frosted |

| DIMENSIONS IN INCHES | | | |
|----------------------|--------|-------|----------------|
| Fixture | | | Mounting Plate |
| Diameter | Height | o.a.h | Diameter |
| 19 | 2.25 | 5 | 10 |

| CERTIFICATION | | |
|---------------|----------|---------------|
| Label | Location | Rating |
| cETL | Ceiling | Damp Location |

| LAMPING | | | | | | | | | |
|-----------|----------|---------|-------------|--------|--------|-----|-----------------|-------------------|---------|
| Lamp Type | Lamp qty | Wattage | Max Wattage | Base | Kelvin | CRI | Initial Lumen's | Delivered Lumen's | Voltage |
| LED | 1 | 40w | 40w | Module | 3000k | 90 | 3400 | 2045 estimated | 120v |

| COMPATIBLE DIMMER'S |
|---------------------|
| CL, ELV |

| J-BOX TYPE |
|-----------------|
| 4 x 4 Octagonal |

| SUPPLIED |
|----------|
| |

| SPECIAL NOTES | |
|---------------|--|
| | |

| | | | |
|---------------------|--|-------------|--|
| Project Name | | | |
| Date | | Type | |