



Assembly and Installation Instructions for Model's

500220DW



CAUTION - RISK OF FIRE

Installation of this fixture should be done by a licensed electrician or by a person familiar with local electrical codes and the construction and operation of this fixture.

Warning please make sure the electrical breaker is shut off before commencing with this installation

Read and familiarize yourself with these instructions before commencing

This fixture is certified for ceiling mounting is suitable for Wet locations

Package Contents		
Part	Description	Qty
A	Mounting bracket	1
B	J-Box screws	2
C	Fixture assembly	1
D	Wire connectors	3
E	Fixture mounting screws	2
F	Shroud	1
G	Shroud attachment screws	2

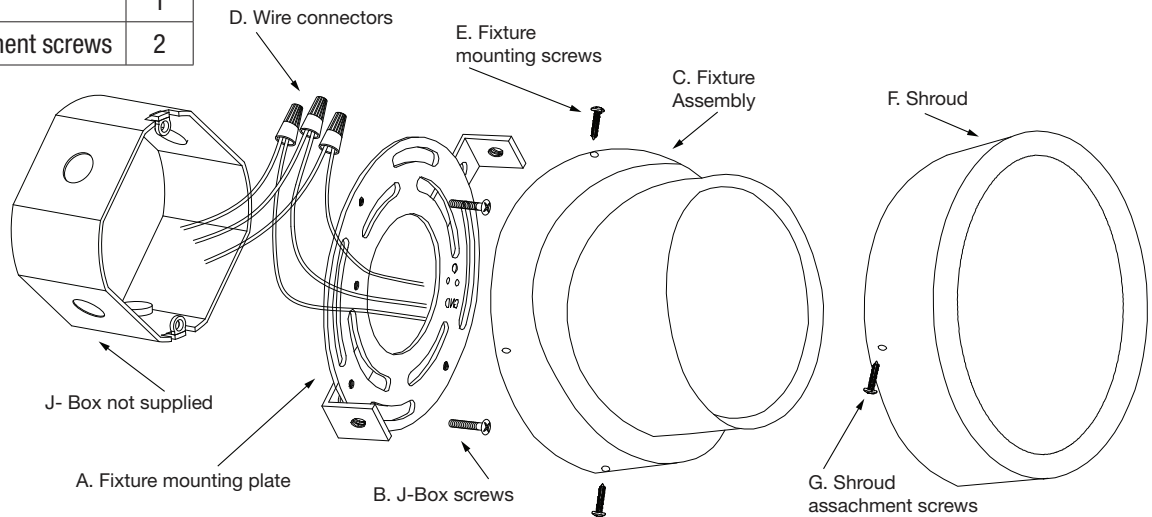
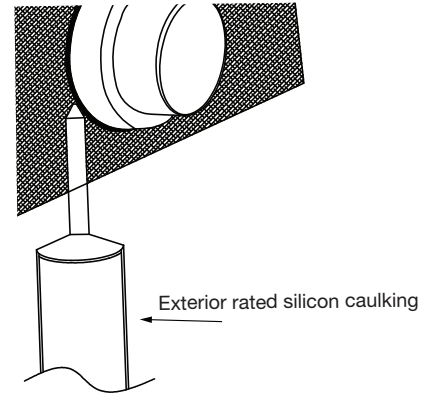

Installing the fixture *please ensure the electrical breaker is switched off before commencing*

- 1 Attach the supplied Mounting bracket (A) with the two supplied Mounting plate bracket (B) to the Junction box.
- 2 Connect the supply wires to the fixture wires using the supplied electrical wire connectors (D). White supply wire to the White fixture wire, Black supply wire to Black fixture wire and the ground Bare Copper or Green wire to the Green fixture wire. Once the electrical wire connectors are securely fastened it is recommended to tape these connectors with electrical tape.
- 3 Attach the Fixture assembly (C) to the mounting bracket (A) with supplied Fixture mounting screws (E)
- 4 Attach the Shroud (F) to the fixture assembly and secure in place with supplied Shroud attachment screws (G)
- 5 **Caulk** the fixture to prevent water entering the electrical box.
- 6 Switch on the electrical breaker switch and your new fixture is ready for many years of trouble free use